

ngdrive

VARIABLE FREQUENCY DRIVE



BUILT-IN
CONNECTIVITY



NG DRIVE

VARIABLE FREQUENCY DRIVE



TECHNICAL DATA

Single-phase power supply: 1 x 220 - 240 V +/- 10% 50/60 Hz

Three-phase power supply: 3 x 380 - 480 V +/- 10% 50/60 Hz
3 x 230 V +/- 10% 50/60 Hz

Maximum operating current:

6 A (M/T 1,1kW)

10,5 A (M/T 2,2 kW)

8 A (T/T 2,2 kW)

10,5 A (T/T 230V 2,2 kW)

Degree of protection: IP 55

Operating room temperature: -10°C +50°C

Communication protocols: RS485 MODBUS RTU

Up to 6 NgDrives can be connected to each other wirelessly

Variable speed control unit with graphic display suitable for managing both pressure boosting and circulation systems.

NgDrive can control water recirculation pumps in heating or air conditioning systems, domestic hot water circulation pumps, or pressure boosting system pumps. In case of water circulation systems, the following settings are possible: constant differential pressure; constant speed; constant differential temperature; constant temperature; proportional differential pressure. It allows performance to be adapted to actual system demand. Thanks to a gradual speed decrease, it protects the pump from water hammer. Cooling is by means of a built-in fan that guarantees protection against overheating. The control unit adjusts the motor speed to match demand, saving energy and reducing component wear.

The graphic display makes reading and setting operations easy. A wizard makes system start-up extremely simple. Adaptable to products of other brands, it can also be used in systems with submersible pumps.

Remote control of the variable frequency drive is possible thanks to the DConnect app and Wi-Fi, Ethernet and Bluetooth connection (Smartphone, PC, Tablet).

NgDrive is available in different models to suit different power supplies and pump power ratings, in accordance with the maximum current delivered. It can perform various functions, such as anti-seizing, warning in case of excessive number of pump restarts, anti-freeze and dry run protection, day/night operation setup, pressure boost at peak times. Gradual system filling (slow filling mode) can be set directly using a wizard. Among other things, it is also possible to choose to stop the pumps at minimum frequency or via flow sensor.

INSTALLATION SCHEME

When NgDrive is installed on inline pumps, depending on the position of the pump, NgDrive can be turned relative to the motor so that the display is always easy to see. If the installation is located very high up and the display is no longer accessible, the pump's setup can be done through Dconnect, via Bluetooth.

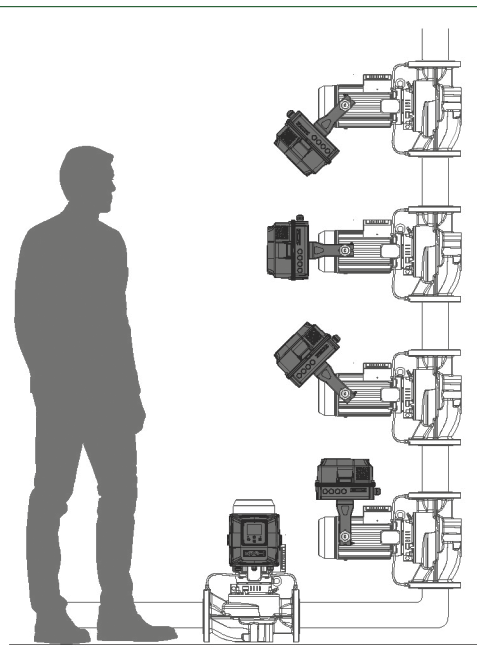

VARIABLE FREQUENCY DRIVE

NG DRIVE

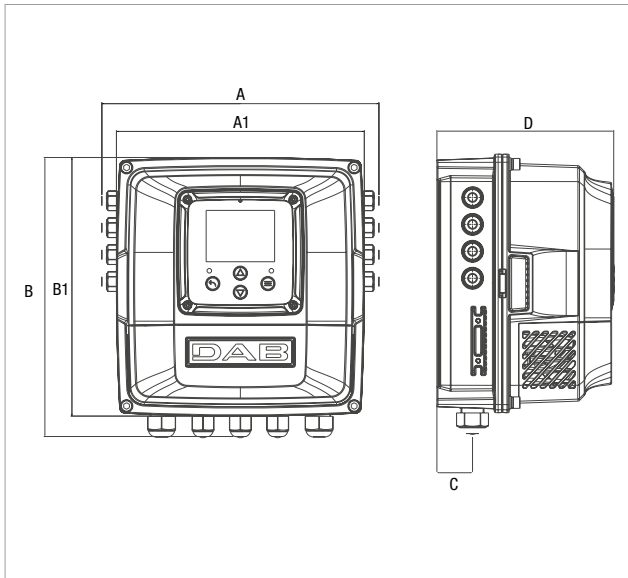

MODEL	A	A1	B	B1	C	D	PACKING DIMENSIONS			WEIGHT Kg
							L/A	L/B	H	
NGDRIVE 6A M/T 220-240V 50/60 1.1kW	241	216	243	226	31	154	350	300	200	6
NGDRIVE 10.5A M/T 220-240V 50/60 2.2kW	241	216	243	226	31	154	350	300	200	6
NGDRIVE 10.5A T/T 220-240V 50/60 2.2kW	241	216	243	226	31	154	350	300	200	6
NGDRIVE 8A T/T 380-480V 50/60 2.7kW	241	216	243	226	31	154	350	300	200	6

MODEL	MOTOR NOMINAL MAX CURRENT A	INPUT VOLTAGE VAC	OUTPUT VOLTAGE VAC
NGDRIVE 6A M/T 220-240V 50/60 1.1kW	6	1 x 220 - 240 +/- 10%	3 x 230
NGDRIVE 10.5A M/T 220-240V 50/60 2.2kW	10.5	1 x 220 - 240 +/- 10%	3 x 230
NGDRIVE 10.5A T/T 220-240V 50/60 2.2kW	10.5	3 x 220 - 240 +/- 10%	3 x 230
NGDRIVE 8A T/T 380-480V 50/60 2.7kW	8	3 x 380 - 480 +/- 10%	3 x 400

USER INTERFACE

NGDRIVE

DAB'S SMART SYSTEM

Used in conjunction with **DAB Virtual Cockpit** and **DConnect**, it becomes a very smart system, with an intuitive and effective user experience. Setting up the system is extremely quick thanks to the wizard: it takes 5 steps and 5 minutes to completely set up the plants.



USER INTERFACE

Employing a consistent vertical scroll logic, the homepage also provides quick access to menus for the individual sections. On a single clear, user-friendly screen, **DAB Virtual Cockpit** summarizes all the key information to be monitored in order for the system controlled with **NgDrive** to work at its best.

The buttons are cross-arranged for easy interaction and the menu navigation symbols are intuitive.

SYSTEM OPERATION STATUS

PUMP OPERATING OVERVIEW

CONNECTIONS

CONNECT TO THE DCONNECT APP

	Press to browse the menu. Press to increment the selected parameter. Press and hold to increase the increment speed.
	Press to browse the menu. Press to decrement the selected parameter. Press and hold to increase the decrement speed.
	Press to confirm and go to the next screen. Press to access the selected menu page.
	Press to cancel and return to the previous screen. Press to leave the current menu page.

DISPLAY DASHBOARD

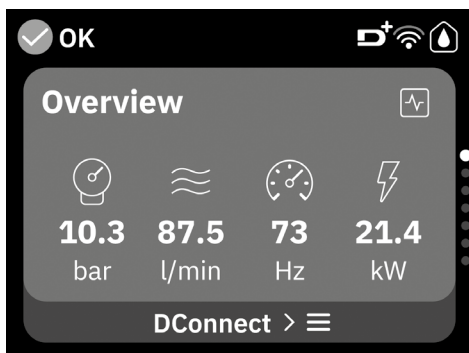

The Dashboard screen displays certain parameters depending on the following conditions: whether or not there is a flow meter, and whether or not the pump belongs to a group. On the main screen, the various parameters are displayed depending on the following conditions: whether or not there is a flow meter, and whether or not the pump belongs to a group. The parameters that can be displayed are as follows:

- Delivery pressure reading
- Speed of rotation reading
- Flow reading (only where enabled)
- Absorbed power reading (only where the pump is NOT configured as part of a group)

USER INTERFACE AND PROTOCOLS

NGDRIVE

OPTIONAL CONFIGURATIONS

- Configuration of suction pressure sensor functionality

This function allows you to set the unit up to detect low suction pressure

- Flow meter configuration

Allows the pump to stop on flow when no consumption is detected. Without the use of the flow meter, you can use pump stop on minimum frequency mode

- I/O configuration



By accessing the relevant page, you can set the type of inputs and outputs available in the drive

GENERAL SETTINGS

Allows you to edit and/or view a series of parameters so you can tailor the system's management to your individual needs

System type	OFF delay
Proportional gain	Starting time
Integral gain	Starting frequency
Dry run time	Carrier frequency
Slow fill mode time	Acceleration
Dry run service factor	Maximum speed of rotation
Pump current demand	Minimum rotation frequency
Pump rated voltage	Zero-flow speed
Proportional gain	Pressure setpoint maximum limit

NETWORK PROTOCOLS

	Bluetooth: short-range wireless data transmission standard (point-to-point). You can connect devices such as mobile phones, personal computers, tablets. Connection via smartphone, directly to NgDrive in case of configuration from smartphone via DConnect app.
	WI-FI: wireless network access for devices such as smartphones, tablets or computers. Direct connection to NgDrive via DConnect app, remotely with IP address.
	Modbus: serial communication protocol, allowing communication between different devices connected to the same network. Through Modbus, NgDrive can be connected to a central supervision system (BMS).

DCONNECT DIGITAL SERVICES

REMOTE CONTROL FOR ELECTRONIC RESIDENTIAL AND COMMERCIAL SYSTEMS

The D.Connect service offers simple and intuitive remote control of your installation, without the need of a server or specialist personnel.

With D.Connect, you can remotely manage your installations as if you were right in front of them.

Thanks to the system operation charts, you will also be able to optimise operation. You will also receive prompt notifications of any system faults.

THE SERVICE ALLOWS TO:

EASILY MONITOR YOUR SYSTEMS

The installations with green status are OK, while the orange ones need attention, and the red ones are experiencing problems.

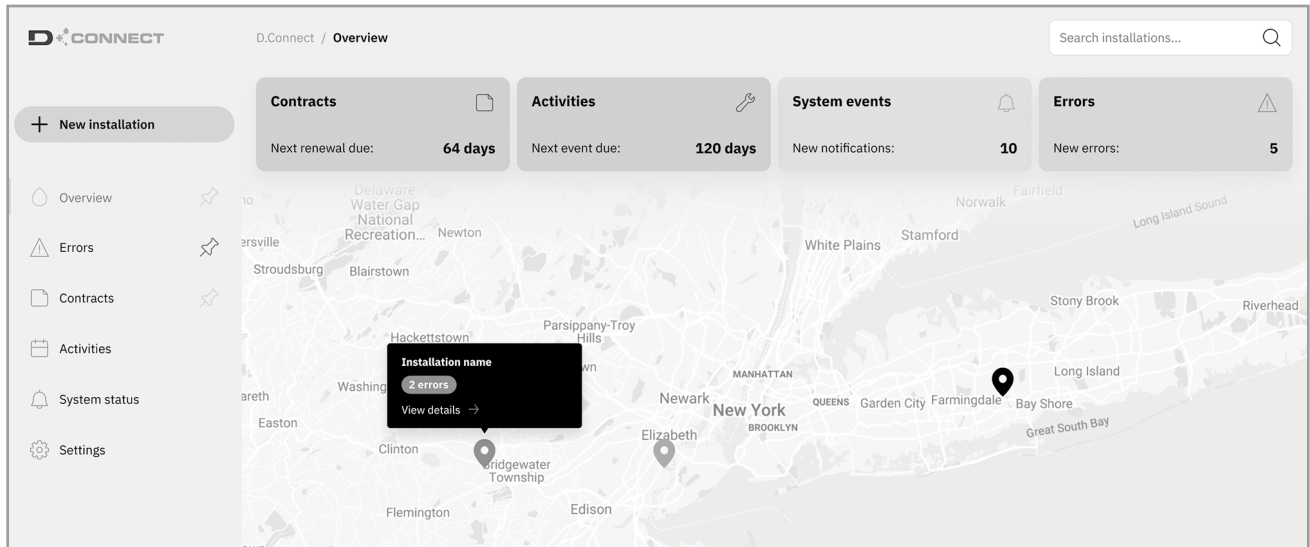

TAKE ANY NECESSARY ACTIONS AS IF YOU WERE RIGHT IN THE PUMP ROOM

Using the internet site or the APPs, you will be able to easily and quickly control your systems.

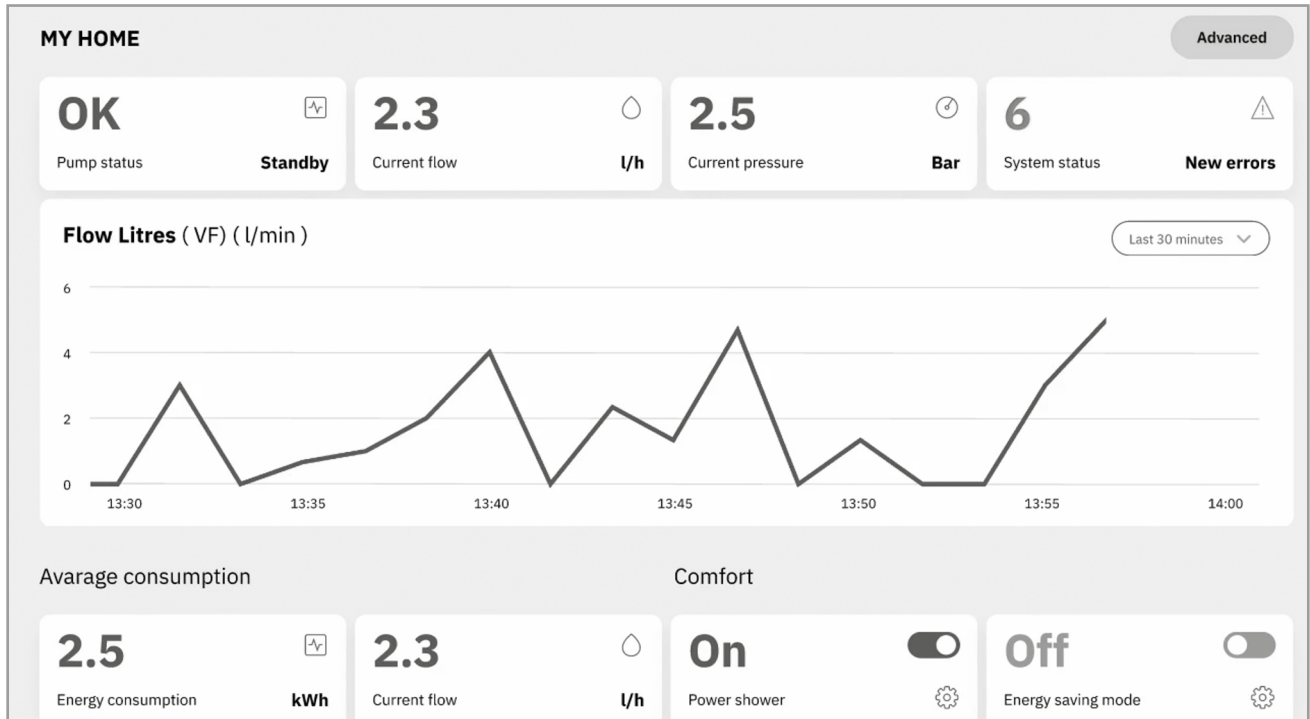

REMOTE ALARMS

In case of alarm, the D.Connect service will promptly send you a notification, so that you can check what is happening and organise a visit to the system before the issue becomes an emergency for your customer.

DCONNECT DIGITAL SERVICES

REMOTE CONTROL FOR ELECTRONIC RESIDENTIAL AND COMMERCIAL SYSTEMS

In order to use the D.Connect service, registration and connected products are required.
Connect to the website: <https://dconnect.dabpumps.com> using Internet Browsers such as Microsoft Edge or Google Chrome.
The Android and iOS D.Connect APPs can be downloaded from the relevant Stores:

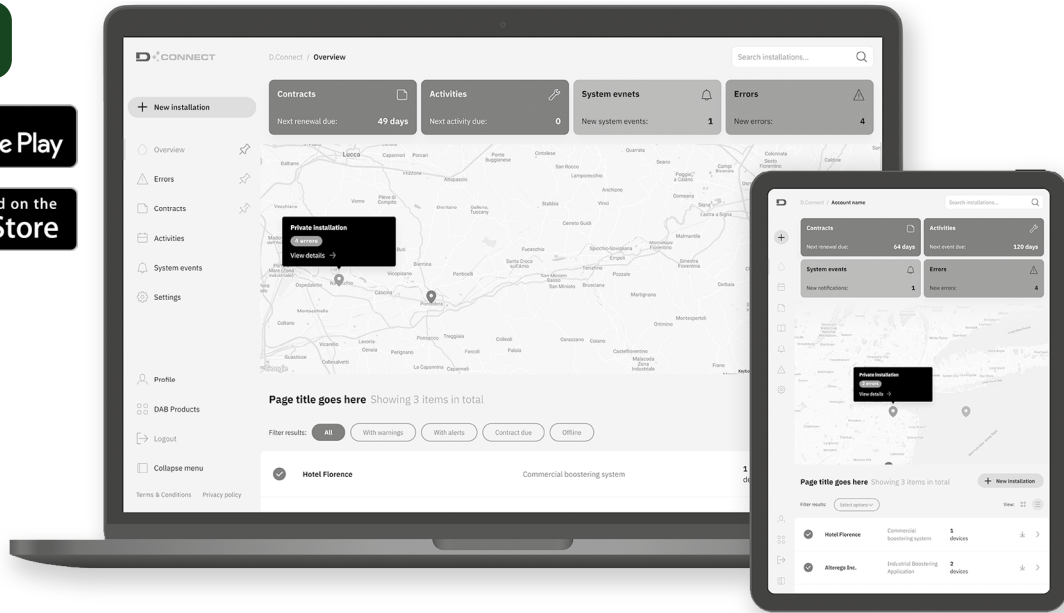

WHAT PRODUCTS CAN YOU MANAGE USING THE D.CONNECT SERVICE?

NgDrive, NgPanel, MCE/P, MCE/C, ADAC, Active driver Plus, Ebox, Evoplus, Esybox, Esybox mini, Esybox Diver, Dtron 3, Esybox Max.

For more information visit: www.internetofpumps.com



Simple and intuitive digital service for remote monitoring of DAB products: it allows you to find all the information you need, supervise the operation of the systems, or change the setting parameters.

APP DAB LIVE! Available for Esybox mini³ live!



It makes easier for end users to supervise domestic systems in order to optimize consumption and maximize comfort, also thanks to Power Shower and Sleep Mode functions.

DCONNECT DIGITAL SERVICES

DATA RETENTION 1 MONTH MONITORING AND CONTROL

BASIC PACKAGE

1 YEAR SERVICE

2 trial months included Possibility to upgrade to a higher package at any time.

DATA PACKAGE

12 MONTHS SIM DATA TRAFFIC RENEWAL SERVICE

DATA RETENTION 12 MONTH MONITORING AND CONTROL

PLUS 12 PACKAGE

1 YEAR SERVICE

PLUS 36 PACKAGE

3 YEARS SERVICE

KIT MODEM WiFi + WALL CHARGER + SIM

12 MONTHS OF TRAFFIC INCLUDED

CONSTRUCTION FEATURES ELECTRICAL SECTION

NGDRIVE

The technological product of over 40 years' experience in the water handling sector. NgDrive is not just a variable frequency drive, it is the hardware component of a fully-fledged smart system, conceived to cater to the needs of its users, not least in its design.

VERSATILITY and EASE of use make NgDrive the most comprehensive controller available in the market. A new generation of variable frequency drives, designed for the control and protection of circulation and pressure booster pumps, adjusting them to suit the system's actual demands, thus resulting in both occupant comfort and real energy savings.

Drawing on cutting-edge TECHNOLOGIES and the DAB group's lengthy experience, NgDrive features a meticulously engineered design that is not just design for design's sake; instead, it was conceived specifically to cater to the needs of its users. Moreover, it is split into two parts that can be separated so that the components inside can even be fitted at different times and serviced without disconnecting any wires.

With the option of being fitted on the actual pump or wall mounted, NgDrive gives you the tool you need to get the most out of the DAB range of pumps and use them in the most efficient way. NgDrive has been designed and built to offer the best user experience: easy to install, set up and monitor.

- 2.8" TFT colour display
- A single software for different applications (circulation and pressure boosting)
- Keypad with intuitive commands
- Setup and getting started wizards
- Software updates via app
- Integrated connectivity (Wi-fi, Bluetooth, Wireless, Modbus) for remote control

NgDrive introduces new standards in DAB technology: cooling via built-in fan with speed control based on temperature, and architecture with four microprocessors:

- Wireless communication
- Pump functions managed via display
- Motor control
- Input and output signals

Between two and a maximum of six variable frequency drives can be connected wirelessly.

OPERATING MODES

NgDrive can be used to control pumps both for pressure boosting systems and circulation systems. Constant-pressure control is the method used for pressure boosting applications, while for circulation, the control options are as follows:

- Constant speed
- Constant differential temperature
- Constant temperature
- Proportional differential pressure
- Constant differential pressure

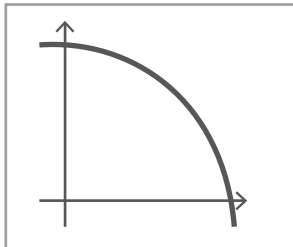

Constant speed

The speed of rotation is kept at a constant rpm. This speed can be set in a range from a minimum value to the circulation pump's nominal frequency. This mode can be set via the control panel.

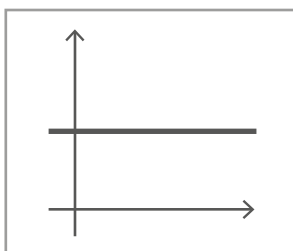

Proportional differential pressure

In this control mode, the differential pressure is reduced or increased as water demand drops or rises. This mode can be set via the control panel, where you can specify the pressure setpoint and, where applicable, the liquid temperature dependence (in this case, you will need to connect a T1 and T2 sensor).

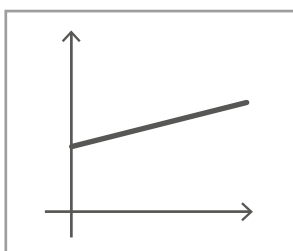

Proportional differential pressure

In this control mode, the differential pressure is reduced or increased as water demand drops or rises. This mode can be set via the control panel, where you can specify the pressure setpoint and, where applicable, the liquid temperature dependence (in this case, you will need to connect a T1 and T2 sensor).

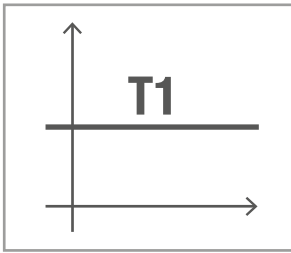

Constant temperature

With this function, the circulation pump increases or decreases flow rate to keep constant the temperature measured by the NTC sensor connected.

You can set 2 operating modes:

- T1 increase mode → if the desired temperature (T_s) is greater than the temperature measured ($T1$), the circulation pump increases flow rate until the temperature reaches T_s .
- T1 decrease mode → if the desired temperature (T_s) is greater than the temperature measured ($T1$), the circulation pump decreases flow rate until the temperature reaches T_s

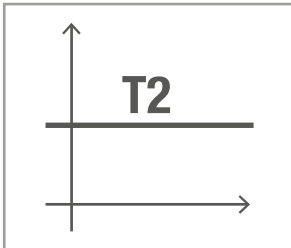

Constant temperature

With this function, the circulation pump increases or decreases flow rate to keep constant the temperature measured by the NTC sensor connected.

You can set 2 operating modes:

- T2 increase mode → if the desired temperature (T_s) is lower than the temperature measured ($T1$), the circulation pump increases flow rate until the temperature reaches T_s .
- T1 decrease mode → if the desired temperature (T_s) is greater than the temperature measured ($T1$), the circulation pump decreases flow rate until the temperature reaches T_s .

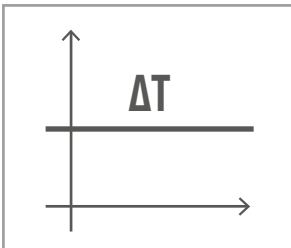

Constant temperature difference

With this function, the circulation pump increases or decreases flow rate to keep constant the T1-T2 temperature difference as an absolute value. This mode can be set via the control panel, where you can specify the temperature setpoint.

CONTROL MODE: PRESSURE BOOSTING

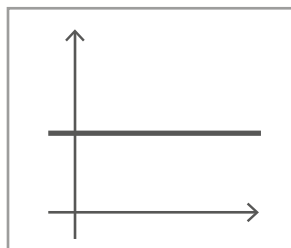

Constant pressure

Head remains constant, regardless of water demand. This mode can be set via the control panel, where you can specify the pressure setpoint.

INPUT AND OUTPUT ELECTRICAL CONNECTIONS

NGDRIVE

NgDrive has an I/O board featuring the following inputs and outputs:

Digital inputs for circulation:

- Remote-controlled pump start and stop
- Remote-controlled lowering of setpoint (economy function)

Digital inputs for pressure boosting:

- Dry run protection
- Remote-controlled pump start and stop
- Setpoint adjustment
- Alarm reset

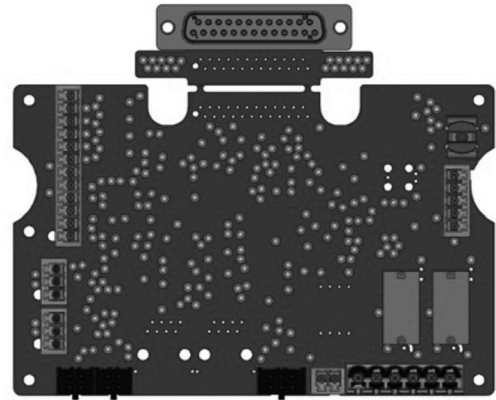

For control in circulation applications, NgDrive allows you to have different commands that you can use based on system requirements:

- Differential pressure, temperature sensor; thermostats and programmable thermostats.

For control in pressure boosting applications, NgDrive can use the following sensors:

- Ratiometric pressure sensor, 4-20mA pressure sensor, pulse flow meter.

For the ratiometric pressure sensor, NgDrive accepts voltage in the range 0-5 V. In multi-drive systems, the ratiometric pressure sensor (0-5V) can be connected to any variable frequency drive in the chain. Ratiometric pressure sensors (0-5V) are recommended, given that they are easy to connect.

Alarm outputs

The controller has two relay contacts, for alerting as to the following alarms:

- Pump running status
- Variable frequency drive error status

RS485 MODBUS RTU CONNECTION

Through the Modbus protocol, NgDrive can be connected with all BMSs (building management systems), either by means of the RS485 port or directly on the I/O board.

Reducing motor speed, even marginally, can lead to an appreciable reduction in power consumption because the absorbed power of an electric motor is proportional to the rpm cubed. For example, a pump powered by the mains that runs at approximately 2950 rpm, will run approximately 20% slower (i.e. at 2360 rpm) when fed with a 40 Hz supply, leading to a saving of 40% in terms of absorbed power.

The motor speed reduction increases pump life significantly, thanks to the reduction of mechanical stress.

Pump performance in relation to variations in rpm

Pump rpm n has a very significant influence on pump performance. In the absence of cavitation phenomena the law of similarity is applicable, as shown in equation 1.

- Flow rate changes in a linear manner with changes in speed.
- Pressure changes in a squared relationship with changes in rpm.
- Power changes in a cubed relationship with changes in rpm.
- A small change in rpm produces a very large change in power.

$$\frac{Q_x}{Q} = \frac{n_x}{n} \quad Q = Q_x \frac{n_x}{n}$$

$$\frac{H_x}{H} = \left(\frac{n_x}{n}\right)^2 \quad H_x = H \left(\frac{n_x}{n}\right)^2$$



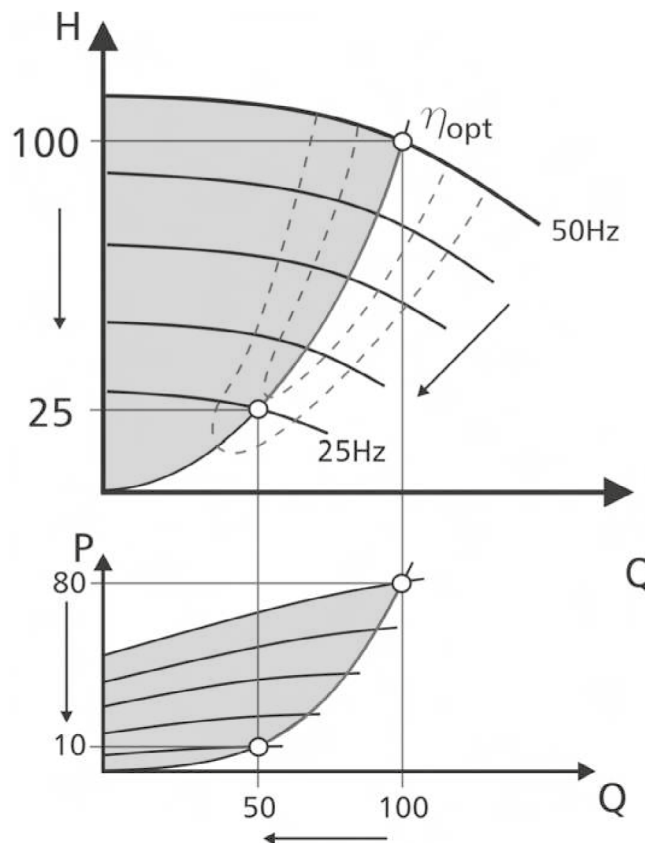

$$\frac{P_x}{P} = \left(\frac{n_x}{n}\right)^3 \quad P_x = P \left(\frac{n_x}{n}\right)^3$$





- a lowering of the flow acc. to the linear function
- a reduction of the head according to a quadratic function
- a reduction of the power consumption acc. to a cubic function!

ACCESSORIES

NGDRIVE

	DESCRIPTION
	DIFFERENTIAL SENSOR 4BAR HUBA (C)
	DIFFERENTIAL SENSOR 10BAR HUBA (C)
	PRESSURE SENSOR 25 BAR COMPL. WITH CABLE (2 MT.)
	PRESSURE SENSOR 25 BAR COMPL. WITH CABLE (4 MT.)
	PRESSURE SENSOR. 4-20 MA - 25 BAR WITH CABLE (1,5 MT)
	FLOW SENSOR F3H13 (CABLE NOT INCLUDED)
	FLOW SENSOR F3H15 (CABLE NOT INCLUDED)

	DESCRIPTION
	MOUNT. FLANGE FOR FLOW SENS. F3H13 PLAST. PIPE 2" (63 MM)
	MOUNT. FLANGE FOR FLOW SENS. F3H13 PLAST. PIPE 2" 1/2 (75 MM)
	MOUNT. FLANGE FOR FLOW SENS. F3H13 PLAST. PIPE 3" (90 MM)
	MOUNT. FLANGE FOR FLOW SENS. F3H13 PLAST. PIPE 4" (110 MM)
	MOUNT. FLANGE FOR FLOW SENS. F3H13 PLAST. PIPE 6" (160 MM)
	MOUNT. FLANGE FOR FLOW SENS. F3H13 MET. PIPE 2" (63 MM)
	MOUNT. FLANGE FOR FLOW SENS. F3H13 MET. PIPE 3" (88.9 MM)
	MOUNT. FLANGE FOR FLOW SENS. F3H13 MET. PIPE 4" (114.3 MM)
	MOUNT. FLANGE FOR FLOW SENS. F3H13 MET. PIPE 6" (168.3 MM)
	MOUNT. FLANGE FOR FLOW SENS. F3H13 MET. PIPE 8" (219.1 MM)
	FLOW SENSOR CABLE 2 MT.
	FLOW SENSOR CABLE 4 MT.
	FLOW SENSOR CABLE 10 MT.
	FLOW SENSOR CABLE 32 MT.
	FLOW SENSOR CABLE 49 MT.
	PRESSURE SENSOR CABLE 4 MT.
	PRESSURE SENSOR CABLE 10 MT.
	PRESSURE SENSOR CABLE 32 MT.
	PRESSURE SENSOR CABLE 49 MT.
	PRESSURE SENSOR CABLE 99 MT.



It is also possible to find further information and technical details from DNA by connecting to the address: dna.dabpumps.com





DNA[®]

PUMPS SELECTOR



On-line product selection



DAB PUMPS LTD.

Unit 6 Gilbert Court
Newcomen Way, Severalls Park
CO4 9WN
Colchester
ordersuk@dwtgroup.com
Tel. +44 0333 777 5010



DAB PUMPS IBERICA S.L.

Calle Verano 18-20-22
28850 - Torrejón de Ardoz - Madrid
Spain
Info.spain@dwtgroup.com
Tel. +34 91 6569545



DAB PUMPS (QINGDAO) CO. LTD.

No.10 Xindong Road
Jiulong Town,
Jiaozhou City
266319 Qingdao (Shandong) - China
sales.cn@dwtgroup.com
Tel. +86 400 186 8280
Fax +86 53286812210



DAB PUMPS BV

*Hofveld 6 C1
1702 Groot Bijgaarden - Belgium
info.belgium@dwtgroup.com
Tel. +32 2 4668353



DAB PUMPS HUNGARY KFT.

H-8800
Nagykanizsa, Buda Ernő u.5
Hungary
Tel. +36 93501700



DAB PUMPS DE MÉXICO, S.A. DE C.V.

Av Amsterdam 101 Local 4
Col. Hipódromo Condesa,
Del. Cuauhtémoc CP 06170
Ciudad de México
Tel. +52 55 6719 0493



DAB PUMPS B.V.

Statenlaan, 4
5223 LA, 's-Hertogenbosch
Nederland
info.nl@dabpumps.com
Tel. +31 416 387280



DAB PUMPS POLAND Sp. z o.o.

Ul. Janka Muzykanta 60
02188 Warszawa - Poland
sprzedaz@dabpumps.com.pl



DAB PUMPS OCEANIA PTY LTD

426 South Gippsland Highway,
Dandenong South VIC 3175 - Australia
info.oceania@dwtgroup.com
Tel. +61 1300 378 677



DAB PUMPS INC.

3226 Benchmark Drive
Ladson, SC 29456 - USA
info.usa@dwtgroup.com
Tel. 1- 843-797-5002
Fax 1-843-797-3366



DAB PUMPS GMBH

Am Nordpark 3
D - 41069 Mönchengladbach - Germany
info.germany@dwtgroup.com
Tel. +49 2161 47388-0
Fax +49 2161 47388-36



DAB PUMPS SOUTH AFRICA (PTY) LTD

Twenty One industrial Estate,
16 Purlin Street, Unit B, Warehouse 4
Olifantsfontein - 1667 - South Africa
info.sa@dwtgroup.com
Tel. +27 12 361 3997



PT DAB PUMPS INDONESIA

Satrio Tower lantai 26
unit C-D, Jl. Prof. Dr. Satrio Kav. C4,
Kel. Kuningan Timur, Kec. Setiabudi, Kota Adm.
Jakarta Selatan, Prov. DKI Jakarta. - Indonesia
Tel. +62 2129222850